

Distinctive Characteristics

Antirotation design, standard on noncylindrical levers, mates toggle and bushing; bottom of toggle has two flatted sides which fit into a complementary opening inside bushing.

Antijamming design protects contacts from damage due to excessive downward force on actuator.

High torque bushing construction prevents rotation or separation from frame during installation.

High insulating barriers increase isolation of circuits in multipole devices and provide added protection to contact points.

Molded diallyl phthalate case has a UL flammability rating of 94V-0.

Epoxy sealed terminals prevent entry of solder flux and other contaminants.

Prominent external insulating barriers increase insulation resistance and dielectric strength.

Interlocked actuator block, lever, and interior guide prevent switch failure due to biased lever movement.

Clinching of frame to case well above base and terminals provides 1,500V dielectric strength.

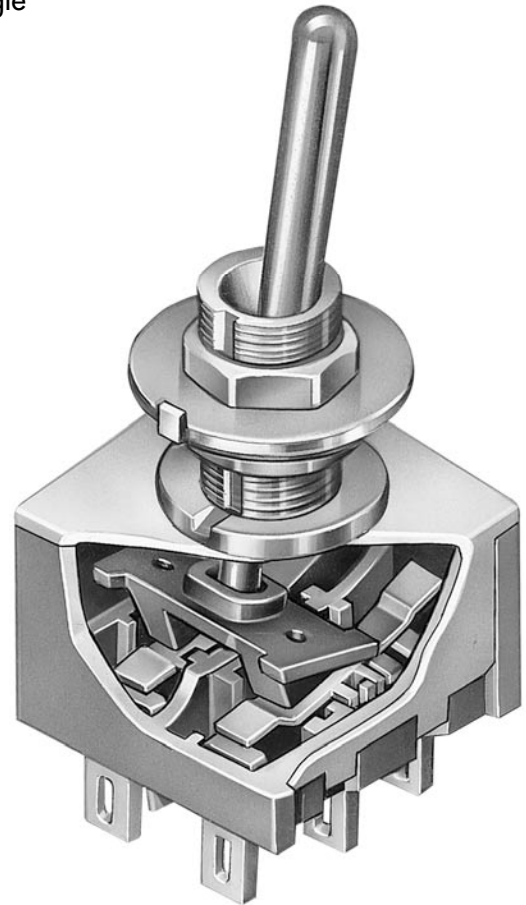

Actual Size

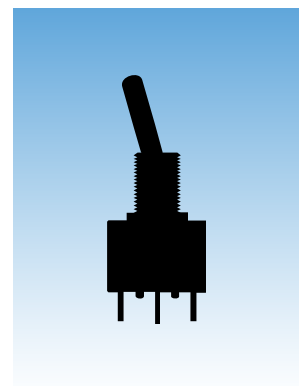

General Specifications

Electrical Capacity (Resistive Load)

Power Level (code W):	6A @ 125V AC & 3A @ 250V AC 4A @ 30V DC for On-None-On & On-None-Off; 3A @ 30V DC for all other circuits
Logic Level (code G):	0.4VA maximum @ 28V AC/DC maximum (Applicable Range 0.1mA ~ 0.1A @ 20mV ~ 28V)
Logic/Power Level (code A):	Combines W & G ratings Note: Find additional explanation of dual rating & operating range in Supplement section.

Other Ratings

Contact Resistance:	10 milliohms maximum for silver; 20 milliohms maximum for gold
Insulation Resistance:	1,000 megohms minimum @ 500V DC
Dielectric Strength:	1,000V AC minimum between contacts for 1 minute minimum; 1,500V AC minimum between contacts and case for 1 minute minimum
Mechanical Life:	100,000 operations minimum; 50,000 operations minimum for flat, locking, & splashproof devices
Electrical Life:	25,000 operations minimum for silver; 50,000 operations minimum for gold; 50,000 operations minimum for silver at 3A @ 125V AC
Nominal Operating Force:	3.92N for Single Pole; 4.41N for Double Pole; 6.86N for Three Pole; 7.85N for Four Pole
Angle of Throw:	25°

Materials & Finishes

Toggle:	Brass with chrome plating	Frame:	Stainless steel
Bushing:	Brass with nickel plating	Support Bracket:	Steel with tin plating
Case:	Diallyl phthalate resin (UL94V-0)		
Movable Contactor:	Phosphor bronze with silver or gold plating		
Movable Contacts:	Silver alloy (code W); copper with gold plating (code G); or silver alloy with gold plating (code A)		
Stationary Contacts:	Silver with silver plating (code W); copper or brass with gold plating (code G); or silver with gold plating (code A)		
Terminals:	Copper or brass with silver plating; or copper or brass with gold plating		

Environmental Data

Operating Temp Range:	-30°C through +85°C (-22°F through +185°F)
Humidity:	90 ~ 95% humidity for 96 hours @ 40°C (104°F)
Vibration:	10 ~ 55Hz with peak-to-peak amplitude of 1.5mm traversing the frequency range & returning in 1 minute; 3 right angled directions for 2 hours
Shock:	50G (490m/s ²) acceleration (tested in 6 right angled directions, with 5 shocks in each direction)
Sealing:	Panel seal bushing options B3 & D3 meet IP67 of IEC60529 Standards

Installation

Mounting Torque:	3.0Nm (26.55 lb•in) double nut for large bushing; 1.5Nm (13 lb•in) double nut & 0.7Nm (6 lb•in) single nut for all other bushings
-------------------------	--

Processing

Soldering:	Wave Soldering (PC version) for Gold: See Profile A in Supplement section. Manual Soldering for Gold: See Profile A in Supplement section. Wave Soldering (PC version) for Silver: See Profile B in Supplement section. Manual Soldering for Silver: See Profile B in Supplement section. Note: Lever must be in OFF (center) position while soldering.
Cleaning:	These devices are not process sealed. Hand clean locally using alcohol based solution.

Standards & Certifications

Flammability Standards:	UL94V-0 for case
UL Recognized:	All models recognized at 6A @ 125V AC, 3A @ 250V AC or 0.4VA maximum @ 28V DC maximum; UL File No. WOYR2.E44145; add "/U" to end of part number to order UL mark on switch.
C-UL Recognized:	All models recognized at 6A @ 125V AC, 3A @ 250V AC or 0.4VA maximum @ 28V DC maximum; C-UL File No. WOYR8.E44145; add "/C-UL" to end of part number to order C-UL mark on switch.
CSA Certified:	All models recognized at 6A @ 125V AC or 3A @ 250V AC or 0.4VA maximum @ 28V maximum; CSA File No. 023535-0-000; add "/C" to end of part number to order CSA mark on switch.



TYPICAL SWITCH ORDERING EXAMPLE

M20

POLES			
1	SPST	SPDT	
2	DPST	DPDT	SP3T
3	3PDT		
4	4PDT	DP3T	

CIRCUITS			
*1	ON	NONE	OFF
2	ON	NONE	ON
3	ON	OFF	ON
5	ON	NONE	(ON)
8	(ON)	OFF	(ON)
9	ON	OFF	(ON)
**4	ON	ON	ON
**6	(ON)	ON	(ON)
**7	ON	ON	(ON)

() = Momentary
 * ON-NONE-OFF circuit available in 1- and 2-pole only.
 ** 3-ON circuits

1

SMALL TOGGLES	
S	.413" (10.5mm) Bat
S2	.200" (5.08mm) Bat
S3	.256" (6.5mm) Bat
E	.450" (11.4mm) Flatted
*E2	.256" (6.5mm) Flatted
E4	.840" (21.3mm) Flatted
*Q	.550" (14.0mm) Cone
*Q2	.640" (16.26mm) Cone
*Q4	.840" (21.3mm) Cone
*C	.571" (14.5mm) Color Tipped Cone
D	.840" (21.3mm) Color Capped Cone
K1	.370" (9.4mm) Paddle
K2	.559" (14.2mm) Paddle

Specify cap color for toggles C, D, K1 & K2 at the end of the part number.
 * Available on 1- and 2-pole only.

LARGE TOGGLES	
B	.453" (11.5mm) Large Bat
B2	.689" (17.5mm) Large Bat
R	.610" (15.5mm) Large Flatted

LOCKING LEVER	
L	.201" (5.1mm) Dia. Locking Lever

3

SMALL BUSHINGS	
S1	.350" (8.9mm) Threaded with Keyway
S2	.350" (8.9mm) Smooth with Keyway
A1	.280" (7.1mm) Threaded with Keyway
A2	.280" (7.1mm) Smooth with Keyway
D1	.350" (8.9mm) Threaded with D Flat
D4	6mm .350" (8.9mm) Threaded with D Flat
D3	.350" (8.9mm) Threaded Splashproof with D Flat (combines only with S & S2)
S4	6mm .350" (8.9mm) Threaded with Keyway
D8	6mm .350" (8.9mm) Threaded Splashproof with D Flat (combines only with S & S2)

LARGE BUSHINGS	
B1	Large .472" (12mm) Threaded with Keyway
B3	Large .472" (12mm) Threaded Splashproof with D Flat

BUSHINGS FOR LOCKING LEVERS	
L1	.291" (7.4mm) Threaded with Keyway for Lever Lock
L4	6mm .291" (7.4mm) Threaded with Keyway for Lever Lock
L2	Smooth with Keyway for Lever Lock
L3	.295" (7.5mm) Threaded Splashproof with D Flat for Lever Lock
L8	6mm .295" (7.5mm) Threaded Splashproof with D Flat for Lever Lock

S1

CONTACT MATERIALS & RATINGS	
W	Silver; Rated 6A @ 125V AC & 3A @ 250V AC
G	Gold; Rated 0.4VA max @ 28V AC/DC max
A	Gold over Silver; Rated 6A @ 125V AC & 0.4VA max @ 28V AC/DC max

TERMINALS	
01	Solder Lug
02	Quick Connect
03	.250" (6.35mm) Straight PC
05	.425" (10.8mm) Wirewrap
06	.750" (19.05mm) Wirewrap
07	.964" (24.5mm) Wirewrap
08	1.062" (27.0mm) Wirewrap

01

OPTIONAL CAPS	
For Small Bat Toggles	
B	For S Bat Toggle
C	Conical Cap for S Bat Toggle
For Large Bat Toggles	
R	For B Toggle
V	For B2 Toggle

CAP COLORS	
A	Black
B	White
C	Red
E	Yellow
F	Green
G	Blue
H	Gray (for K1 & K2 paddles)

For Locking Lever	
Supplied with nickel plated cap as standard.	

Optional Aluminum Caps	
A	Black
C	Red
G	Blue
H	Gray

DESCRIPTION FOR TYPICAL ORDERING EXAMPLE

M2013SS1W01

.413" (10.5mm) Bat Toggle

1/4"-40 .350" (8.9mm) Threaded Bushing with Keyway

Silver Contacts with 6-Amp Rating

SPDT ON-OFF-ON Circuit

Solder Lug Terminals

IMPORTANT:
 Switches are supplied without UL, C-UL & CSA marking unless specified. Specific models & ratings noted on General Specifications page.

POLES & CIRCUITS

Pole	Model	Toggle Position () = Momentary			Connected Terminals			Throw & Schematics
		Down <small>Keyway ↘</small>	Center	Up	Down <small>Keyway ↘</small>	Center	Up	
SP	M2011	ON	NONE	OFF	2-3	OPEN	OPEN	SPST
SP	M2012 M2013 M2015 M2018 M2019	ON ON ON (ON) ON	NONE OFF NONE OFF OFF	ON ON (ON) (ON) (ON)	2-3	OPEN	2-1	SPDT
DP	M2021	ON	NONE	OFF	2-3 5-6	OPEN	OPEN	DPST
DP	M2022 M2023 M2025 M2028 M2029	ON ON ON (ON) ON	NONE OFF NONE OFF OFF	ON ON (ON) (ON) (ON)	2-3 5-6	OPEN	2-1 5-4	DPDT
3P	M2032 M2033 M2035 M2038 M2039	ON ON ON (ON) ON	NONE OFF NONE OFF OFF	ON ON (ON) (ON) (ON)	2-3 5-6 8-9	OPEN	2-1 5-4 8-7	3PDT
4P	M2042 M2043 M2045 M2048 M2049	ON ON ON (ON) ON	NONE OFF NONE OFF OFF	ON ON (ON) (ON) (ON)	2-3 5-6 8-9 11-12	OPEN	2-1 5-4 8-7 11-10	4PDT

For 3 Throw (3-On)

Pole	Model	Down	Center	Up	Connected Terminals & Schematics		
SP	M2024 M2026 M2027	ON (ON) ON	ON ON ON	ON (ON) (ON)			
DP	M2044 M2046 M2047	ON (ON) ON	ON ON ON	ON (ON) (ON)			

The SP3T model utilizes a double pole base.

External connection must be made during field installation.

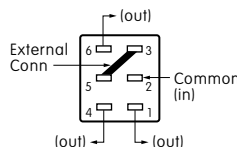

The DP3T model utilizes a four pole base.

External connection must be made during field installation.

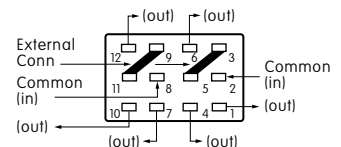

SMALL TOGGLES

S .413" (10.5mm)
Bat

S2 .200" (5.08mm)
Bat

S3 .256" (6.5mm)
Bat

Important:

Toggle length changes based on bushing selected. All illustrations are shown with .350" long bushing. When using a .280" long bushing, toggle length increases .070".

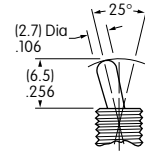
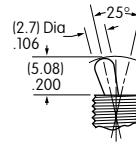
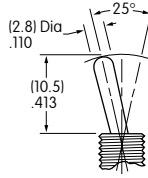

Standard Material & Finish: Brass with Bright Chrome
Contact factory for optional finishes.

E .450" (11.4mm)
Flatted

E2 .256" (6.5mm)
Flatted

E4 .840" (21.3mm)
Flatted

C .571" (14.5mm)
Color Tipped Cone
Supplied with Cap AT445
Material: Polycarbonate

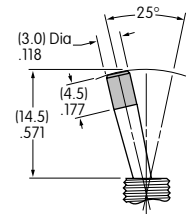
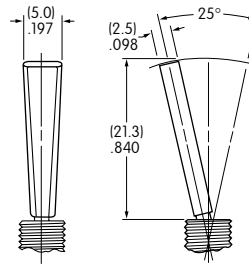
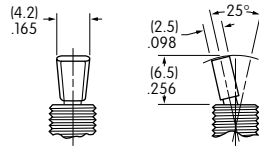
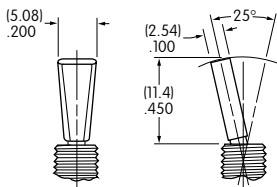

Only Available in 1- & 2-Pole

Only Available in 1- & 2-Pole

Q .550" (14.0mm)
Cone

Q2 .640" (16.26mm)
Cone

Q4 .840" (21.3mm)
Cone

D .840" (21.3mm)
Color Capped Cone
Supplied with Cap AT460
Material: Polyethylene

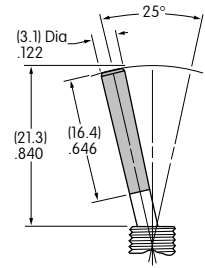
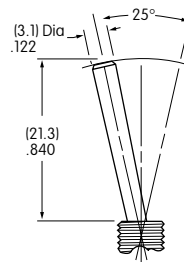
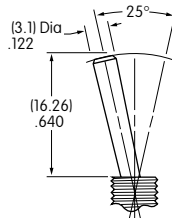
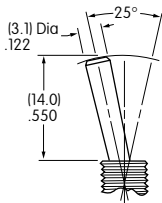

Only Available in 1- & 2-Pole

Only Available in 1- & 2-Pole

Only Available in 1- & 2-Pole

K1 .370" (9.4mm) Paddle
Supplied with Cap AT467
Material: Polyamide

K2 .559" (14.2mm) Paddle
Supplied with Cap AT468
Material: Polyamide

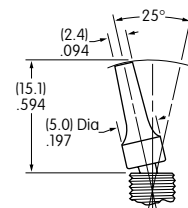
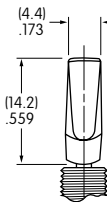
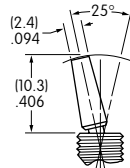
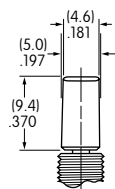

Cap Colors Available:

- A** Black
- B** White
- C** Red
- E** Yellow
- F** Green
- G** Blue
- H** Gray (For K1 & K2 only)

SMALL BUSHINGS

S1 1/4-40 .350" (8.9mm)
Threaded with Keyway

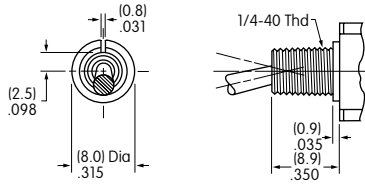

S2 .350" (8.9mm)
Smooth with Keyway

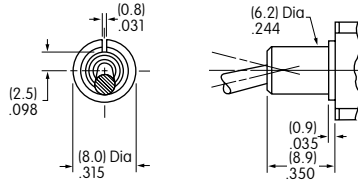

S4 6mm/.350" (8.9mm)
Threaded with Keyway

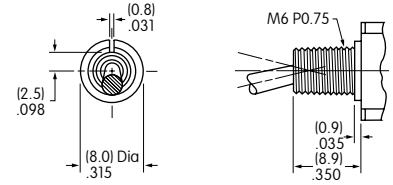

Maximum Panel Thickness with
Standard Hardware: .102" (2.6mm)

Maximum Panel Thickness with
Standard Hardware: .102" (2.6mm)

A1 .280" (7.1mm)
Threaded with Keyway

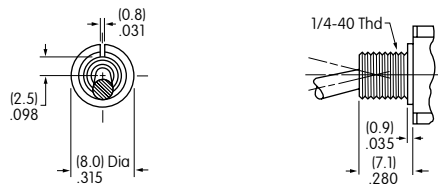

When using this bushing, toggle length is increased by .070". Maximum Panel Thickness with Standard Hardware: .031" (0.8mm)

A2 .280" (7.1mm)
Smooth with Keyway

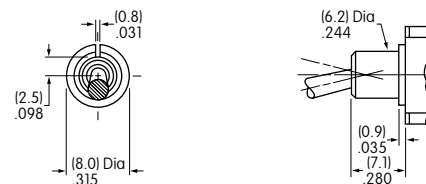

When using this bushing, toggle length is increased by .070".

D1 .350" (8.9mm)
Threaded with D Flat

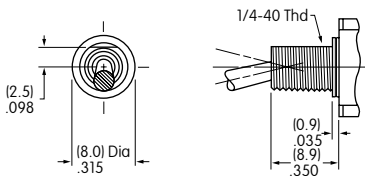

Maximum Panel Thickness with
Standard Hardware: .102" (2.6mm)

D4 6mm/.350" (8.9mm)
Threaded with D Flat

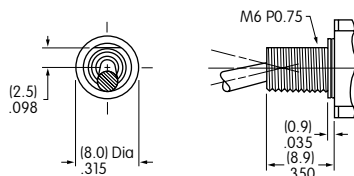

D3 1/4-40 .350" (8.9mm)
Threaded Splashproof with D Flat

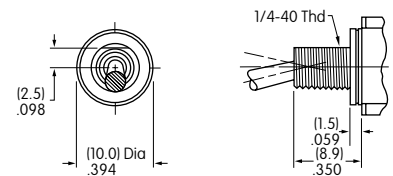

D3 combines only with S & S2 toggles.
Maximum Panel Thickness with
Standard Hardware: .193" (4.9mm)

D8 6mm/.350" (8.9mm)
Threaded Splashproof with D Flat

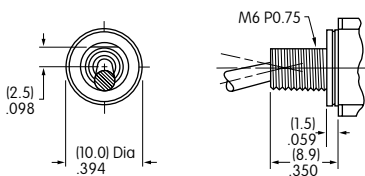

		Standard Hardware Supplied for Small Bushings						
		Bushing Codes	S1/S4	A1	D1/D4	D3/D8	L1/L4	L3/L8
Hardware and Quantity	Hex Nut		2	2	2	1	2	1
	Locking Ring		1	1	0	0	1	0
	Lockwasher		1	1	1	0	1	0
	O-ring		0	0	0	1	0	1

For S1, S2, A1, A2
or S4 Bushing with
Keyway & for L1
or L4 Bushing

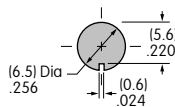

For S1, A1 or
S4 Bushing with
Locking Ring & for
L1 or L4 Bushing

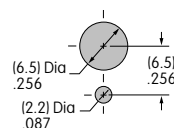

For D1, D4, D3 or
D8 Bushing with
D Flat & for L3
or L8 Bushing

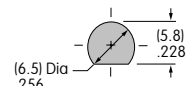

LARGE TOGGLES

Toggle & Bushing Combinations: These toggles combine with the 12mm bushings B1 & B3.

B .453" (11.5mm)
Large Bat

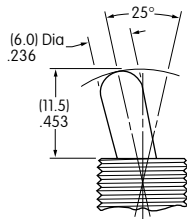

B2 .689" (17.5mm)
Large Bat

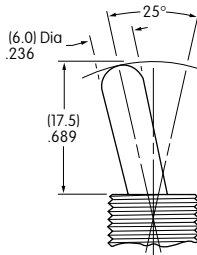

R .610" (15.5mm)
Large Flatted

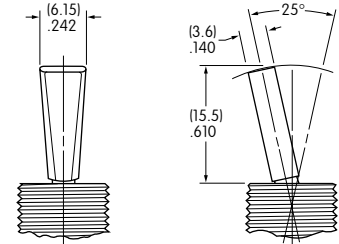

Standard Material & Finish: Brass with Bright Chrome
Optional Finishes: Contact factory for satin chrome or black.

LARGE BUSHINGS

B1 Large .472" (12.0mm)
Threaded with Keyway

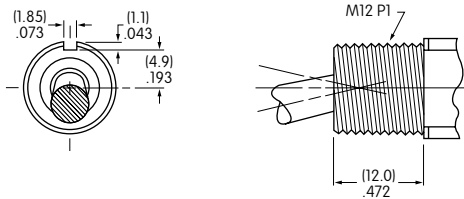

Maximum Panel Thickness with
Standard Hardware: .216" (5.5mm)

Standard Hardware for B1:
1 hex face nut AT503M, 1 locking ring AT506M,
1 lockwasher AT508, and 1 hex backup nut AT527M

B3 Large .472" (12.0mm)
Threaded Splashproof with D Flat

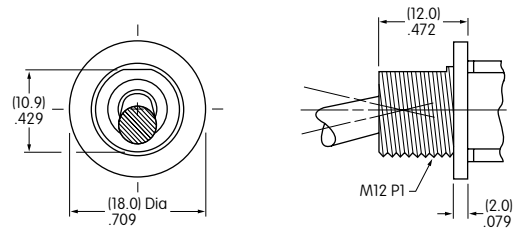

Maximum Panel Thickness with
Standard Hardware: .256" (6.5mm)

Standard Hardware for B3:
1 hex face nut AT503M
and 1 o-ring AT401P

Panel Cutouts

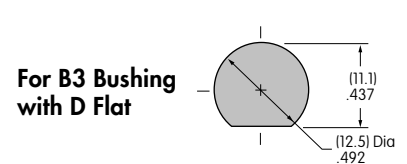
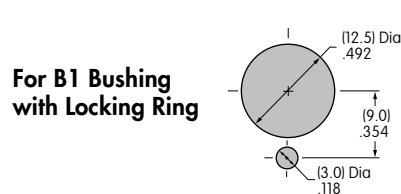
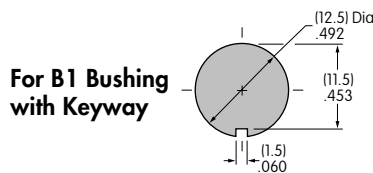

LOCKING LEVER & BUSHINGS

LL1 .291" (7.4mm)
Threaded with Keyway

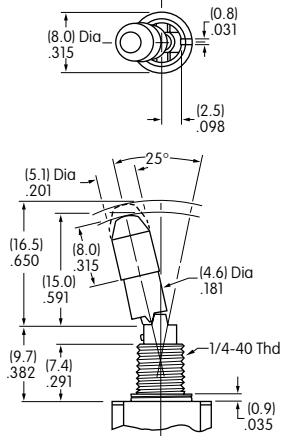

LL4 6mm/.291" (7.4mm)
Threaded with Keyway

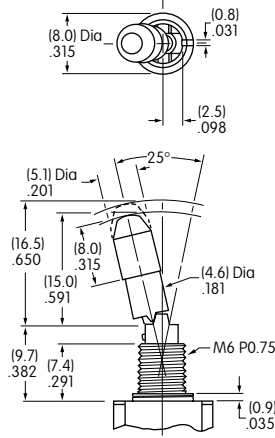

LL2 Smooth with Keyway

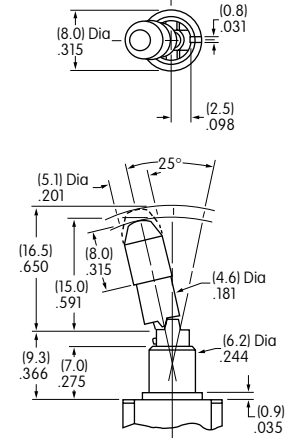

Maximum Panel Thickness with Standard Hardware: .047" (1.2mm)

LL3 .295" (7.5mm)
Threaded Splashproof with D Flat

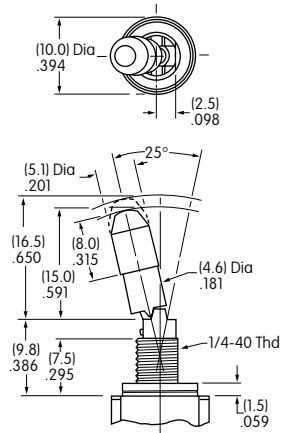

LL8 6mm/.295" (7.5mm)
Threaded Splashproof with D Flat

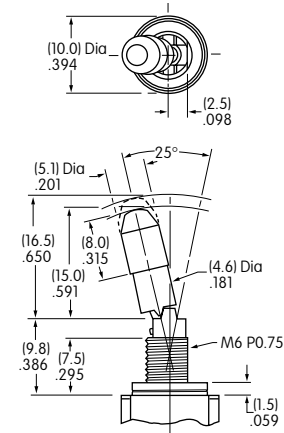

Maximum Panel Thickness with Standard Hardware: .047" (1.2mm)

Lever Material & Finish: Brass with Chrome Plating

Locking Mechanism	on-none-on	on-none-(on)	on-off-(on) on-on-(on)	on-off-on on-on-on	(on)-off-(on) (on)-on-(on)
	2 positions lock	1 position locks	2 positions lock	3 positions lock	1 position locks

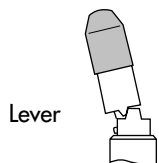

Supplied with
Cap AT427

Cap Material:
Brass with Nickel Plating

Color Codes for Optional Anodized Aluminum Caps

A Black	C Red	G Blue	H Gray (natural aluminum)
----------------	--------------	---------------	-------------------------------------

CONTACT MATERIALS & RATINGS

W

Silver over Silver

Power Level

6A @ 125V AC & 3A @ 250V AC

G

Gold over Brass or Copper

Logic Level

6A @ 125V AC & 3A @ 250V AC

Note: See Supplement section to find complete explanation of operating range.

A

Gold over Silver

Power Level
or Logic Level

6A @ 125V AC
or 0.4VA maximum @ 28V AC/DC maximum

Note: This dual rated option is suitable when two or more identical switches are used in logic and in power circuits within the same application. See Supplement section to find complete explanation of dual rating and operating range.

TERMINALS

01

Solder Lug

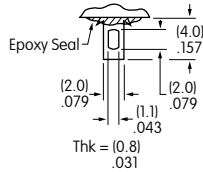

02

.062" (1.57mm) Wide Quick Connect

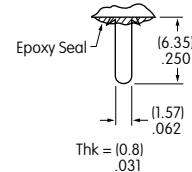

03

.250" (6.35mm) Straight PC

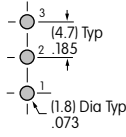
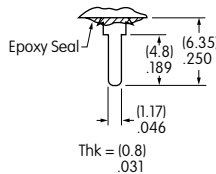

Single Pole

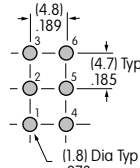

Double Pole

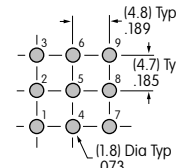

Three Pole

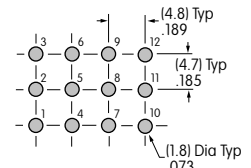

Four Pole

05

.425" (10.8mm) Wirewrap or Extended PC

07

.964" (24.5mm) Wirewrap or Extended PC

06

.750" (19.05mm) Wirewrap or Extended PC

08

1.062" (27.0mm) Wirewrap or Extended PC

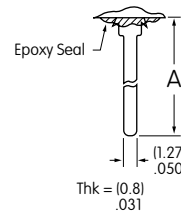

Dimension A = terminal lengths as shown beside the terminal codes at the left.

If using as extended PC terminal, refer to the above footprints.

OPTIONAL CAPS & CAP COLORS

B

AT415 Lever Cap for S Bat Toggle

Material: Polyethylene

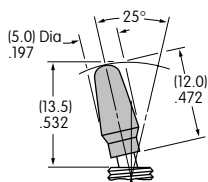

C

AT444 Conical Cap for S Bat Toggle

Material: Polyethylene

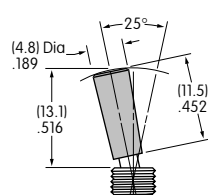

R

AT434 Lever Cap for B Toggle

Material: Polyvinyl Chloride

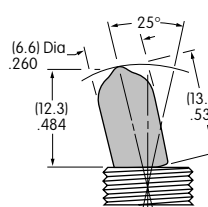

V

AT406 Lever Cap for B2 Toggle

Material: Polyvinyl Chloride

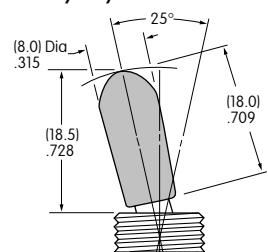

Cap Colors Available:

A

Black

B

White

C

Red

E

Yellow

F

Green

G

Blue

TYPICAL SWITCH DIMENSIONS

Solder Lug

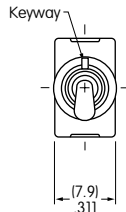

M2012SS1W01

Single Pole

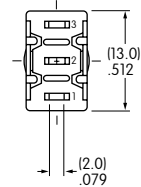
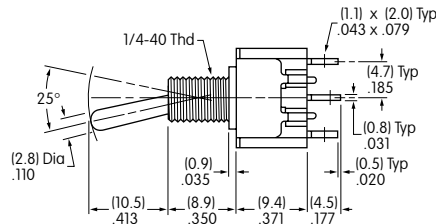

M2011 model does not have terminal 1.

Solder Lug

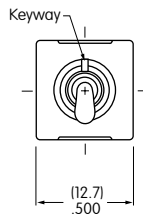

M2022SS1W01

Double Pole

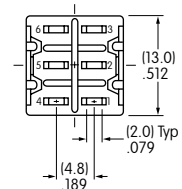
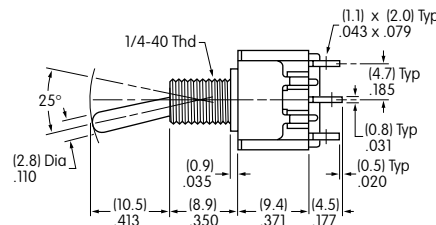

M2021 model does not have terminals 1 & 4.

Solder Lug

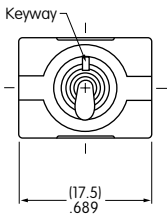

M2032SS1W01

Three Pole

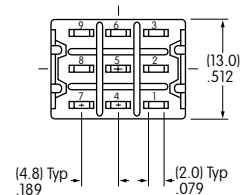
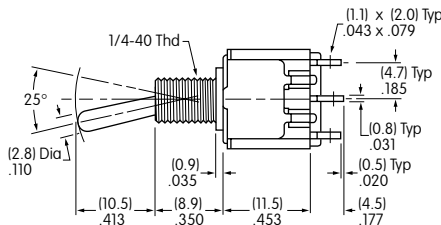

Solder Lug

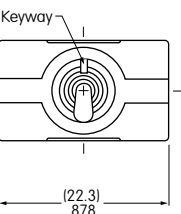

M2042SS1W01

Four Pole

